

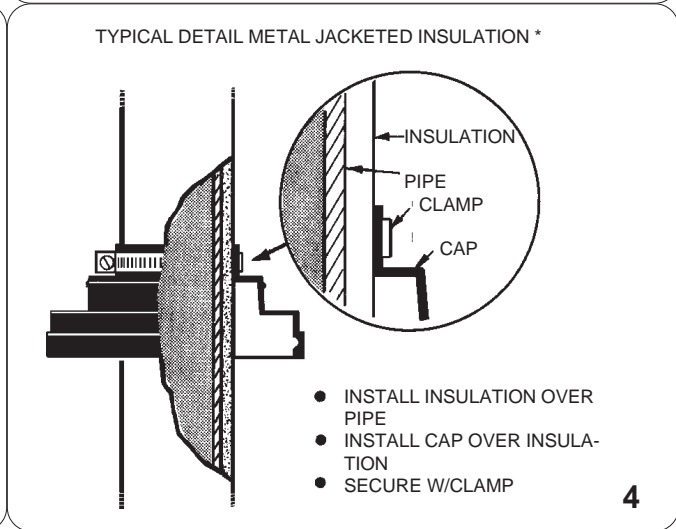

Installation Instructions

PLASTI-FLASH CAP INSTALLATION TECHNIQUES WITH INSULATED PIPE

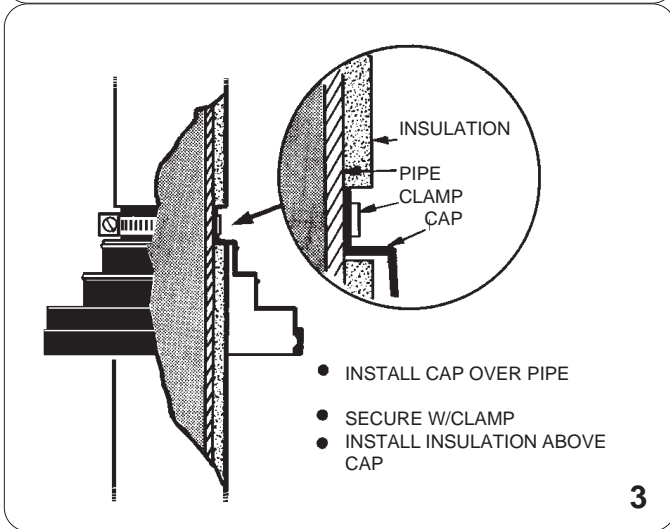
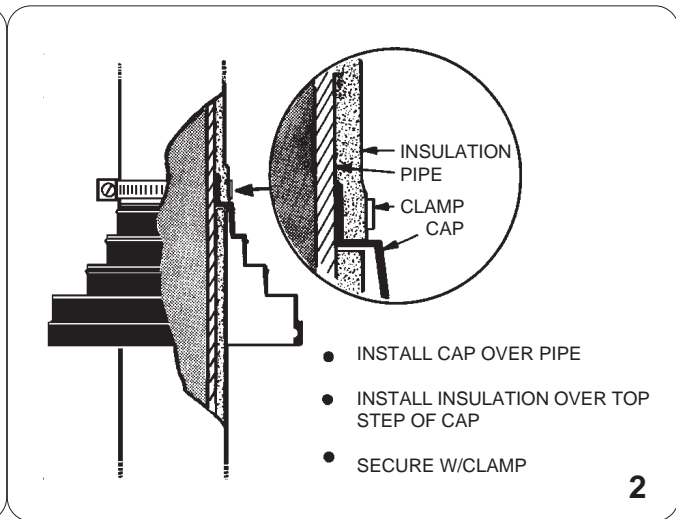
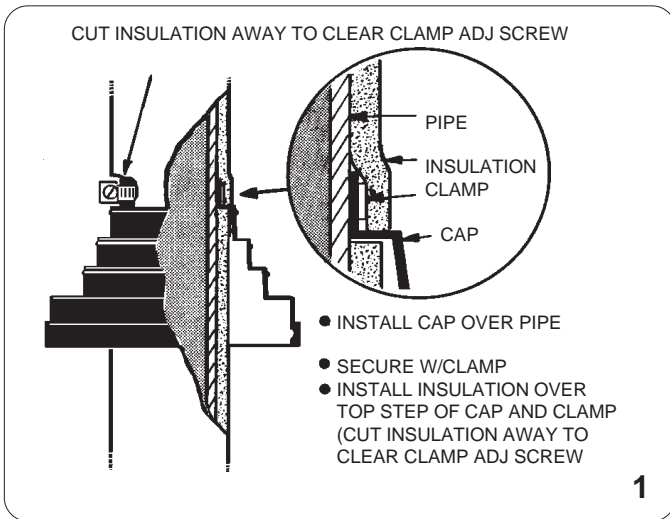

PIPE LAYOUT REFERENCE CHART

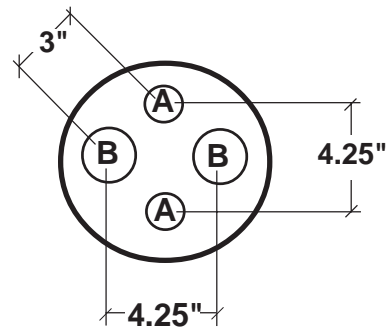
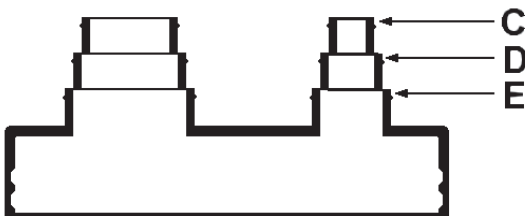

CAP MODEL	A			B		
	C	D	E	C	D	E
C-212	.375"	.75"	1"	1"	1.5"	2"
C-412	1"	1.5"	2"	1"	1.5"	2"
C-481	.375"	.75"	1"	.375"	.75"	1"

*Note: With installation 2 and 4, watertightness depends directly upon watertightness of metal jacketed insulation.



Installation Instructions

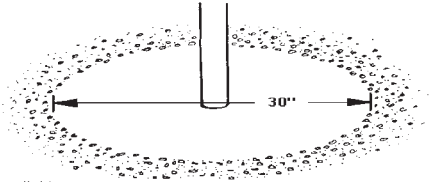

STEP 1

Clean area thoroughly using Roof Manufacturer's approved cleaning material.

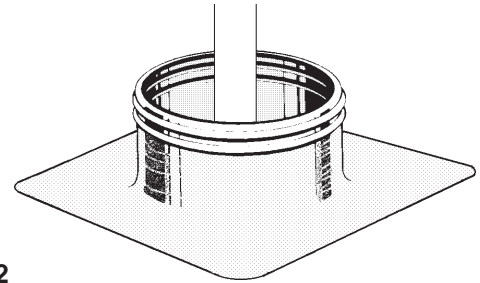

STEP 2

Place PVC base into position and fasten, if required by Roof Manufacturer.

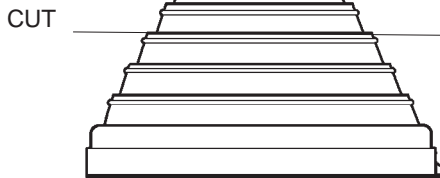

STEP 3

Select proper step of the rubber cap and cut off above index ring. REMEMBER: When in doubt, cut the smaller size.

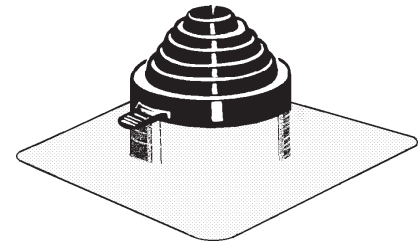

STEP 4

Slip the cap down over the pipe and on to the collar. Press around edge to be sure cap is properly sealed. This will center the unit.

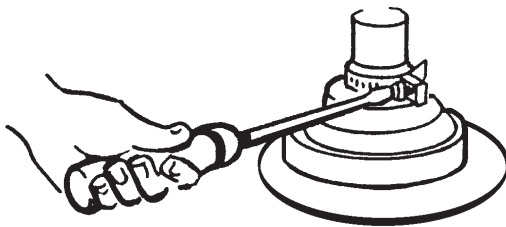

STEP 5

Place clamp around pipe and rubber cap and tighten screw.

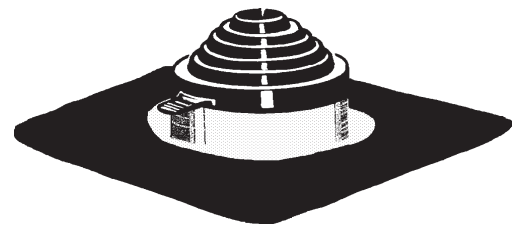

STEP 6

Using Roofing Manufacturer's membrane, cut appropriate shape and place over flange of PVC base.

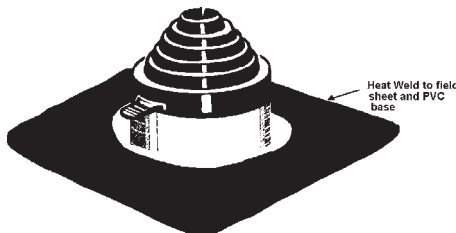

STEP 7

Heat weld flashing material to roof membrane and PVC base per Roof Manufacturer's recommendation.

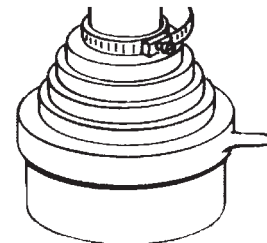

STEP 8

Caulk all seam edges per Roof Manufacturer's recommendations.