

**SPECIFICATION:**

JOSAM 76210 SERIES BLACK PAINTED 9'-10" LONG STEEL ANGLE IRON FRAME WITH COMBINATION ANCHOR TABS / NAILING CLIPS, AND SIX DUCTILE IRON FRAMES TO FIT NON STARFIX 100/1000 SERIES GRATES.

**FRAME & GRATE ASSY**

100 SIZE

SERIES

**76210**

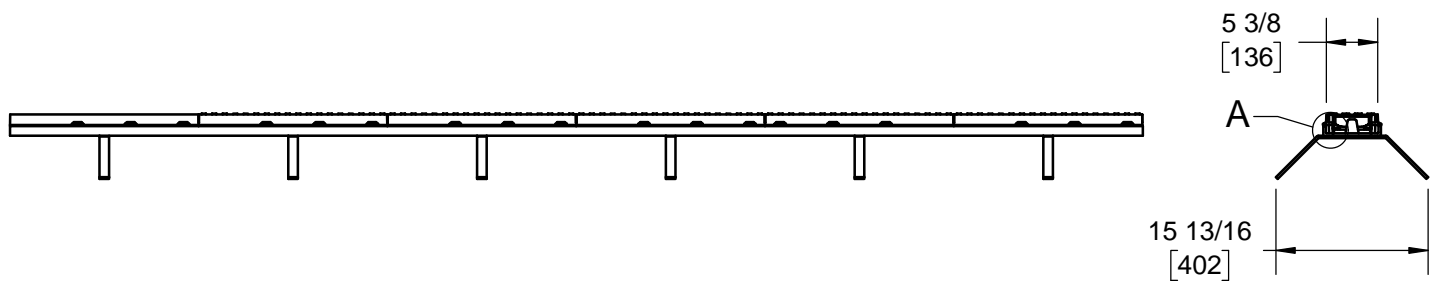
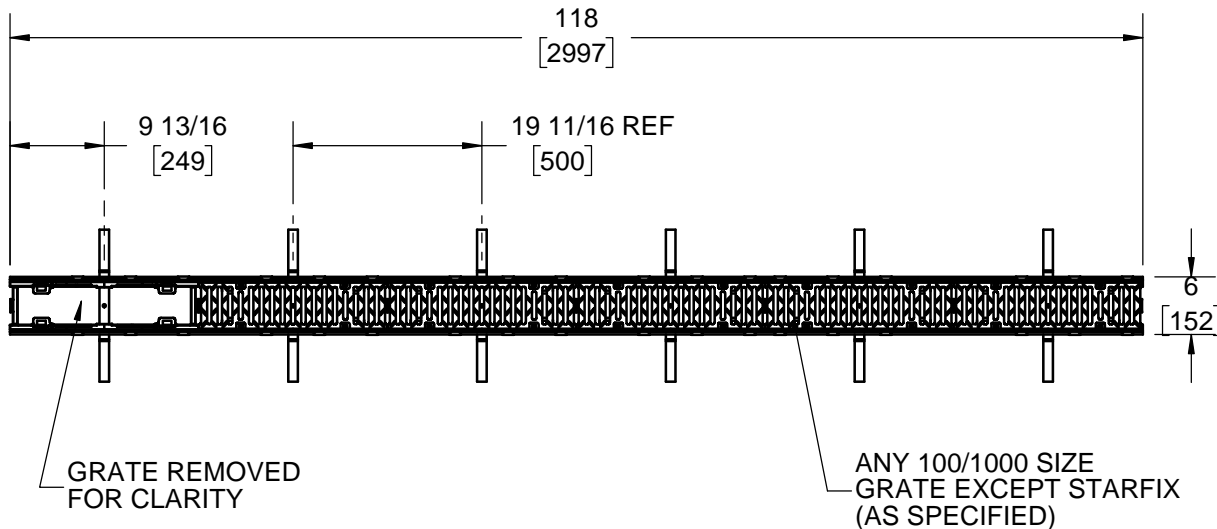
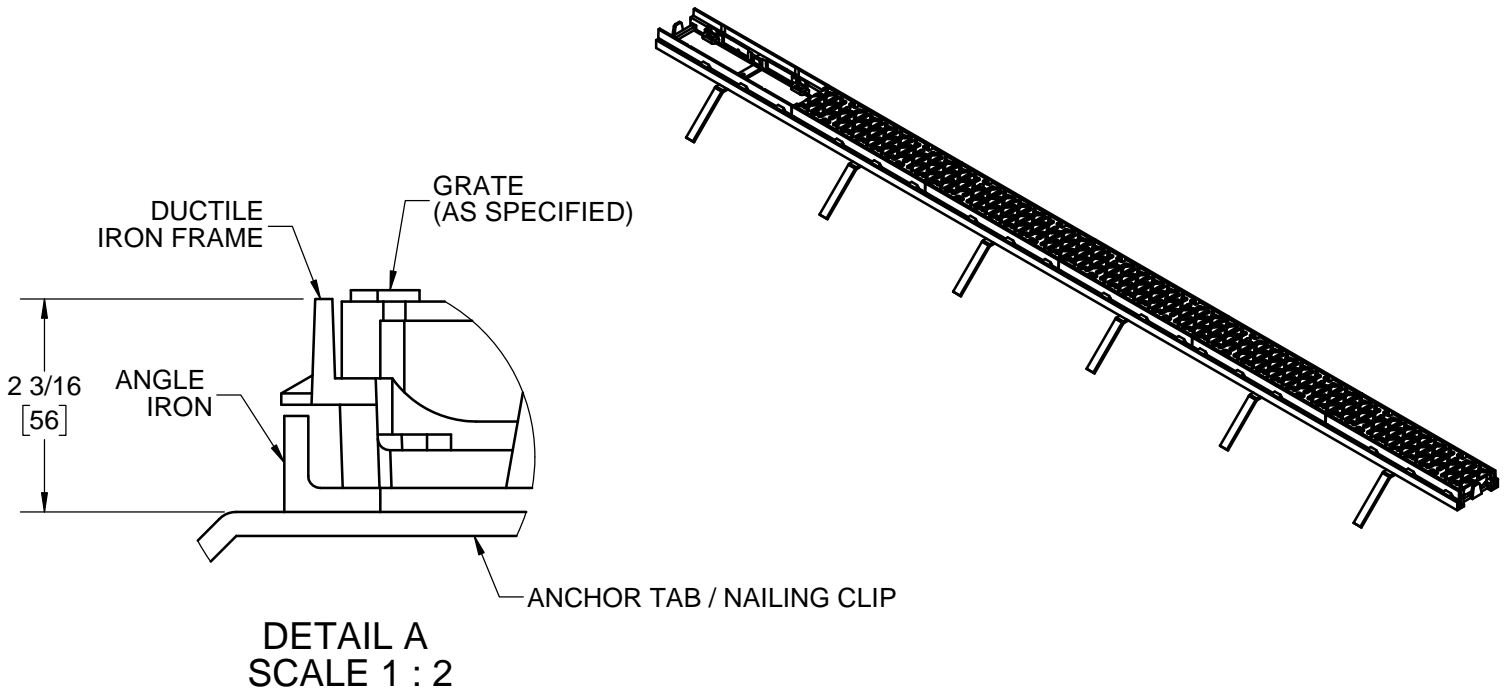

WARNING: Cancer and Reproductive Harm - www.P65Warnings.ca.gov

DATE OF LAST CHANGE: 6/07/18

DIMENSIONS ARE SUBJECT TO MANUFACTURERS TOLERANCES AND CHANGE WITHOUT NOTICE. WE CAN ASSUME NO RESPONSIBILITY FOR USE OF SUPERSEDED OR VOID DATA.

**JOSAM**  
MICHIGAN CITY, INDIANA

NOTES